

Device Layer Safety with CHENZHU



Danping Li



lidp@chenzhu-inst.com

SHANGHAI CHENZHU INSTRUMENT CO.,LTD.

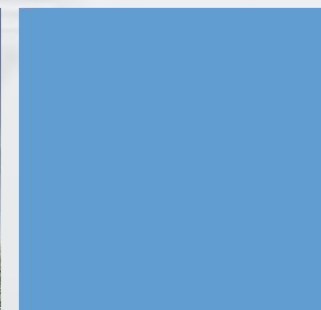
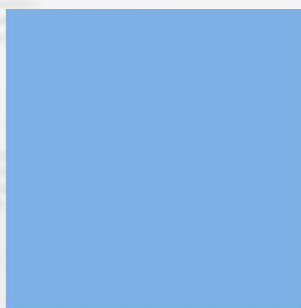

AGENDA



Journey of Excellence

Strategic national team member at Shanghai Institute of Process Automation Instrumentation (SIPAI)

Intrinsic Safety Area



Company Founded

Initiated with 6 colleague on 36m³ office

ISO9001 certified at 2003

Factory with 5000 m² begin production with first 1,000,000 pcs deliver at 2013

Introduce 5 years warranty
Headquarter



2012



Global Direction with New Logo

International coverage with new line of product



2019

Advanced

Sales volume: 700,000+ pcs at 2019

ASEAN Headquarter in Kuala Lumpur , Malaysia

Regional Headquarter

Brief of Company



Experience
23+
 YEARS

Foundation
2002
 Since

Sales Volume
4,000,000
 Pcs

Applications
4000+
 Projects

Factory
2500m²
 In Total

R&D Team
25%
 Work Force



ISO 9001

2003



ISO 14001

2011



OHSAS 18001

2015



Information and Industrialization
 by local government

2016



Safety Production
 Certification

2018

1 Management

- Follow international standards
- Product Lifecycle management

2 Core tech.

- Ex-proof/ signal isolation etc.
- Functional safety

3 Fast release

- Decades of R&D experience
- Internal Lab support

4 Customized

- ODM/OEM service
- Strategic cooperation with international brand



R&D Team

28%

Work Force



R&D Investment

12%

of Sale Revenue



Innovation

110+

Patents



Testing Facility

70+

Capabilities

Test capabilities: 70+ items

Environmental Temperature and Humidity Influence Test

Thermal Shock Test

Temperature Humidity Vibration Test



Radiation and Conduction Test



220kA SPD Surge Impact Test System

8/20 μ s(220kA)



TÜV Rheinland Authorized Lab
based on ISO/IEC 17025

Manufacture Center

CHENZHU factory is continually driven by lean management and flexible production. By our strict quality examination, CHENZHU ensures the production meets the design specification and satisfies our customers.



Manufacturing process quality traceability system

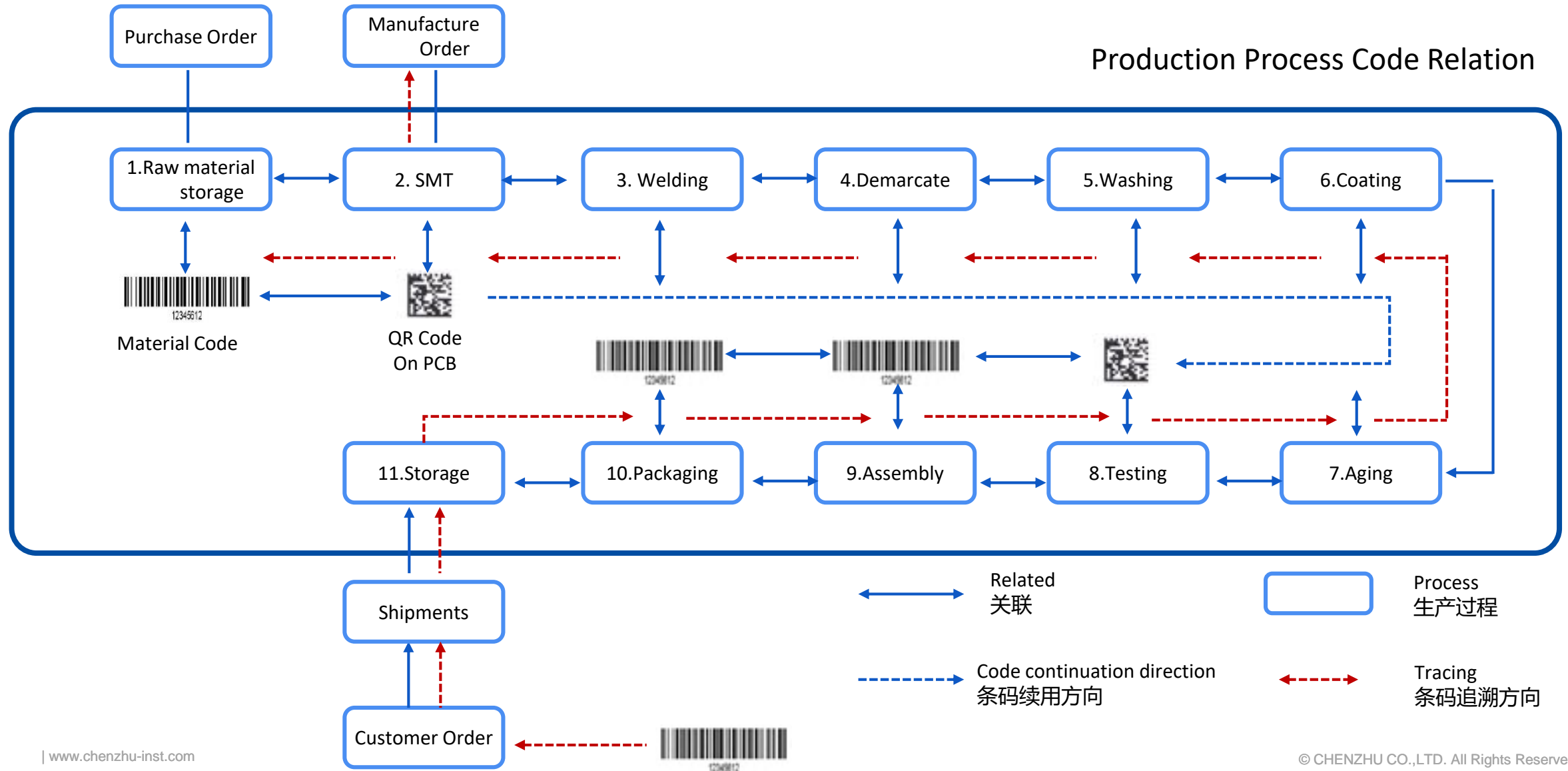

Sales volume: 700,000+ pcs at 2019

2012, CHENZHU received the first TÜV Rheinland SIL certification ;
 Nowadays, CHENZHU owned I.S, SPD, Safety relay, Security module, more than 30 models' SIL certifications.
 2019, the functional safety product occupied **40%** of CHENZHU' s sales volume.

More than 1,000 key customer

The ratio of functional safety products/total sales volume

Unit: 10 K pcs

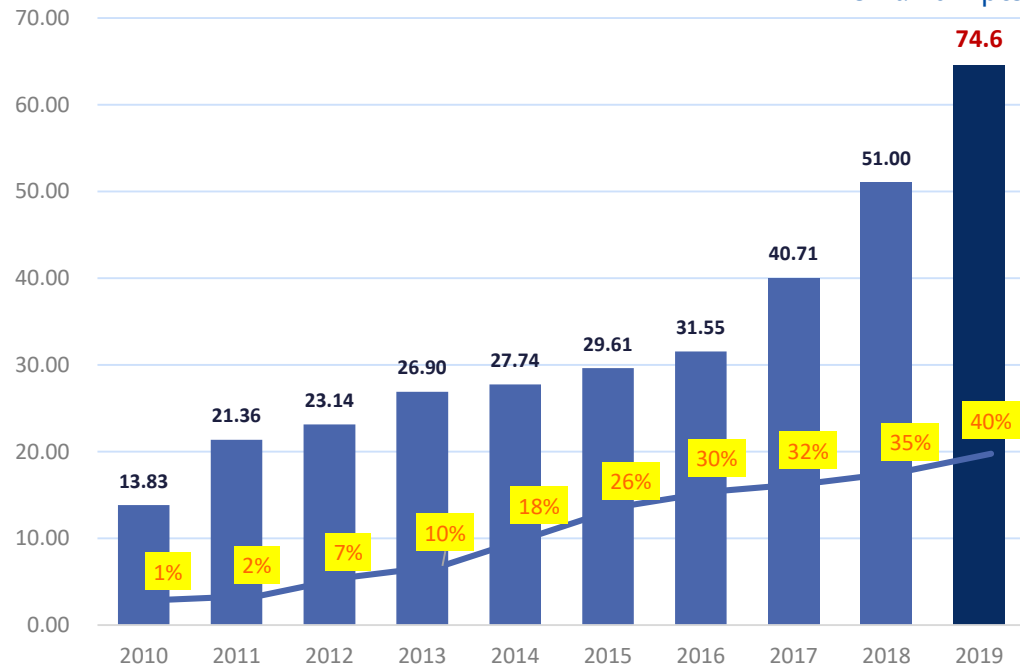



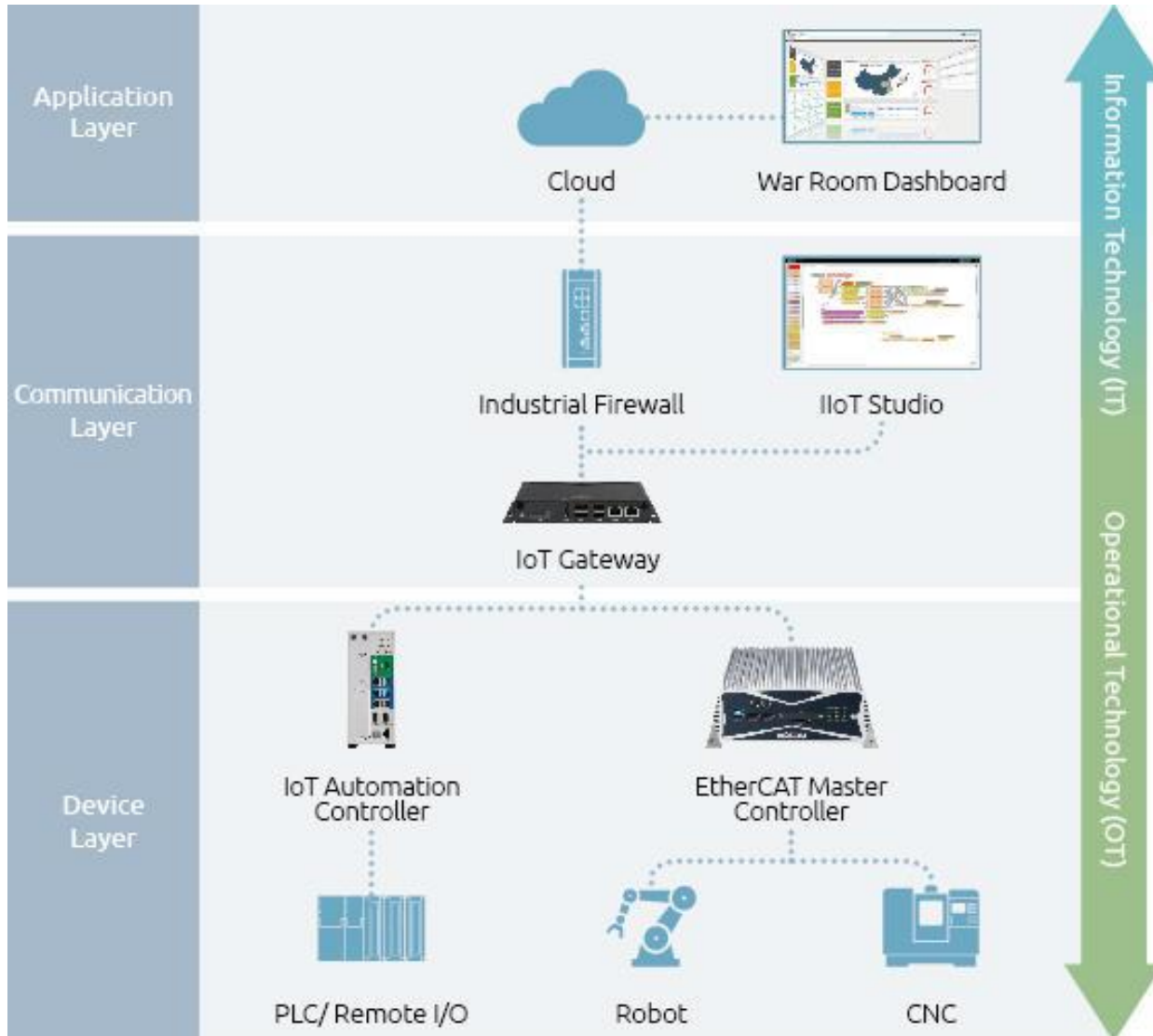















Device layer



1	Safety of Network 1) Intranet 2) Internet
2	Safety of Data 1) Management 2) Operation 3) Interaction
3	Safety of Application
4	Safety of Control
5	Safety of Device

Product portfolio

CHENZHU

Isolated Barrier	 <p>SIL3 IEC61508</p> <p>GS8500-EX Series</p>	 <p>GS4000-EX Series</p>	 <p>GS8200-EX Series</p>	 <p>LBS8000-EX Series</p>	 <p>GS5000-EX Series</p>
SPD	 <p>Power SPD</p>	 <p>SIL3 IEC61508</p> <p>Signal SPD</p>	 <p>SIL3 IEC61508</p> <p>Intrinsic safety SPD</p>	 <p>SIL3 IEC61508</p> <p>Screwable SPD</p>	 <p>Others</p>
Signal Isolators	 <p>CZ3500 Series</p>	 <p>CZ3000 Series</p>	 <p>CZ2000 Series</p>	Smart Controller	 <p>CTOP Series</p>
Safety Relay	 <p>PLe Cat.4 SIL3 IEC61508</p> <p>CZSR Classic</p>	 <p>PLe Cat.4 SIL3 IEC61508</p> <p>CZSR Smart</p>	 <p>SIL3 IEC61508 IEC61511</p> <p>CZSR Process</p>	Others	 <p>Temperature Transmitter</p>



Focus on
the protection
interface product to
the industry process
control system

PA Process Automation Industry



Petroleum



Chemical



Coal mine



Metallurgy



Natural gas



Wind power

FA Factory Automation Industry



Automobile



Food & beverage



Robot



Packaging



Shield machine



Semiconductor

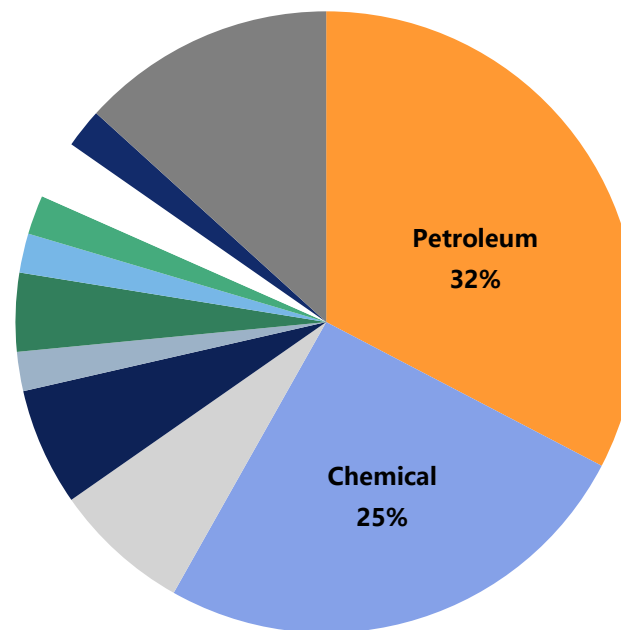

Petrochemical industry accounts most

Why We need Isolated Barriers?

Isolated barrier is used in intrinsic safety **explosion-proof** industry process control system, ensuring safety of intrinsic safety equipment, which are key electronic interfaces of preventing explosion via limiting power in signal transmission between dangerous areas and safety areas.

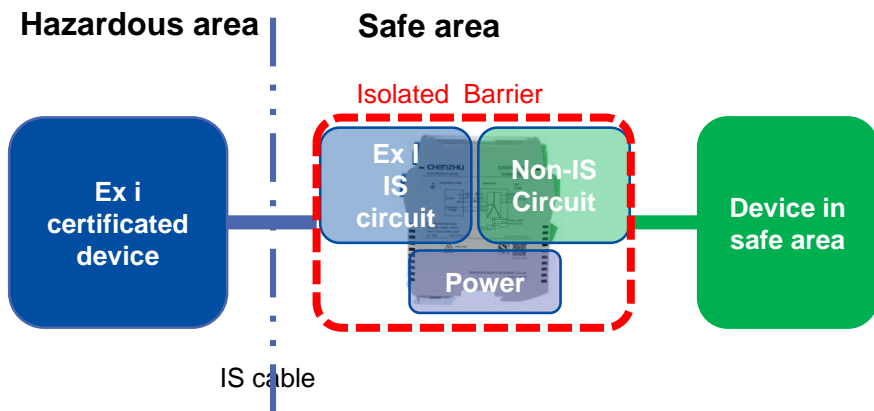

Ex i	Lower than		【 Ex i 】
U _i		≥	U _o
I _i		≥	I _o
P _i		≥	P _o
C _i +	C _c	≤	C _o
L _i +	L _c	≤	L _o

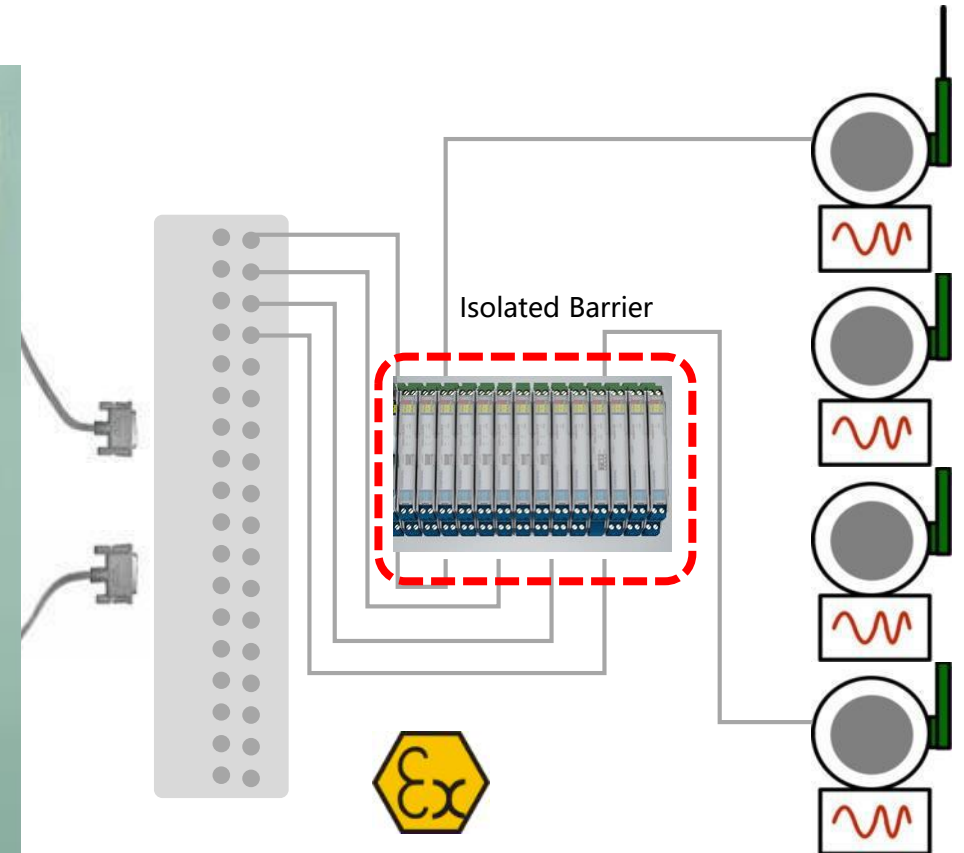

An isolated barrier is a component installed in a safe area. Its circuit structure, including an IS circuit and a non-IS circuit, prevents non-IS circuits from adversely affecting IS circuits. The primary concept behind intrinsic safety is the restriction of available electrical and thermal energy in the system so that ignition of a hazardous atmosphere (explosive gas or dust) cannot occur. This is achieved by ensuring that only low voltages and currents enter the hazardous area, and that no significant energy storage is possible.

Isolated Barrier

	Detection-area isolated barrier	Operation-area isolated barrier
Definition	The field instrument output signal enters the safe area instrument after passing through the isolated barrier, and is generally used to detect the field process parameters.	The safe area instrument output signal controls the field IS instrument action after passing through the isolated barrier, and is generally used to control the field instrument action.
Signal direction	Field instrument → Isolated barrier → Control room	Control room → Isolated barrier → Field instrument
Signal type	AI/DI/TI/PI, etc.	AO/DO
Typical field instrument	Proximity switches, transmitters, temperature sensors, rotary encoders, etc.	Solenoid valve, valve positioner, etc.

Category

- Digital Input
- Digital Output
- Analog Input
- Analog Output
- Pulse Input
- Temperature Input
- Communication barrier
- Special specification barrier

Nowadays, it is customary to define the isolated barrier directly as AI AO DI DO TI PI, etc., with reference to the definition of I/O card, which is closer to the product application.

Selection parameters

Electrical parameters need to match the field instrument / control room instrument / power supply interface signal.

Hazardous-area signal	Safe-area signal	Power supply	Number of channels	Install method
Active 4-20mA	Active4-20mA	Independent power supply	1/1	Rail mounting
Passive 4-20mA	Passive4-20mA	Loop power supply	1/2	Backplane mounting
Voltage source	Voltage source		2/2	
Switch, Namur	Digital signal		3/3	
Transistor OC	Transistor OC		4/4	
Voltage pulse	Voltage pulse			
Communication signal	Communication signal			
RTD/TC/mV/Potentiometer				
Special specification				

Intrinsic safety explosion-proof Isolated Barriers

CHENZHU

 <p>SIL3 IEC61508</p> 	 <p>SIL3 IEC61508</p> 	 	 
<p>GS8500-EX Series</p>		<p>GS4000-EX Series</p>	<p>LBGS8000-EX Series</p>
 	 	<p>We offer the widest selection of products for protection of electrical signals. IECEX, ATEX, DE TUV SIL, JP TIIS certifications were the first one in domestic china</p>  <p>Functional Safety Type Approved www.tuv.com ID: 2600000005</p>     	
<p>GS8200-EX Series</p>	<p>GS5000-EX Series</p>		

Interference preventing Signal Isolators



CZ3500 Series



CZ3000 Series



CZ2000 Series

Signal isolator connects instruments and control systems, **match and transform signals**, resist various kinds of interference via reliable interference preventing technology, which are used in industry process control system, ensuring systems and instruments working stably and reliably in complex electromagnetic environment.

Surge Protective Device

Surge protection device (SPD) releases surge current fast and powerful, protect system avoiding interference from thunderbolt. Maximum Discharge Current I_{max} (8/20us) : 20KA releases surge current fast and powerful, protect system avoiding interference from thunderbolt.



SPD for Signal (EX)

SPD for Signal



SPD for Signal

Screwable SPD

SPD for Power

Data Communication SPD

T series SPD for power—characteristic



hot-pluggable

1 global invention patent (China, Europe, U.S.A) and 2 Chinese invention patents are being applied.



Status indication



Alarm output



Focus on more details



40/80kA
Single mode discharging capacity

1000A
Short-circuit withstand

-40~+110°C
Extreme temperature endurance

Quality assurance



T series SPD for signal—characteristic

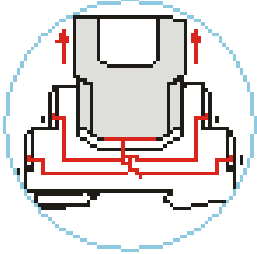

Hot-pluggable

Without disconnecting the circuit, easy for maintenance

1 invention patent, 4 utility model patents.
1 Shanghai high-tech commercialization award



Grounded by rail

- easy mounting, less wiring
- four-point contact for reliable grounding



20kV/10kA (C2)
2500A (D1)

Discharging capacity

More details

- inflammability level V0
- 96h salt mist test, 2G vibration test
- Reliable components and Structures
- Contact points gold plated
-



Safety Relays Application



Safety relay are mainly used for safety control loops, connecting safety sensors and motion controllers of mechanical equipment. When safety sensors detected the dangerous fault signal, safety relay will process these signals and transfer the information to motion controllers and cut the power source to protect the equipment and personnel.

- Classic 22.5mm width, size compatible
- Power, Inputs, Outputs are indicated by red/black, yellow and white at the terminal.
- Various kinds of safety inputs
- 3NO+1NC or 2NO+2NC outputs applied to major applications
- Having delay outputs type
- TUV certification

FA

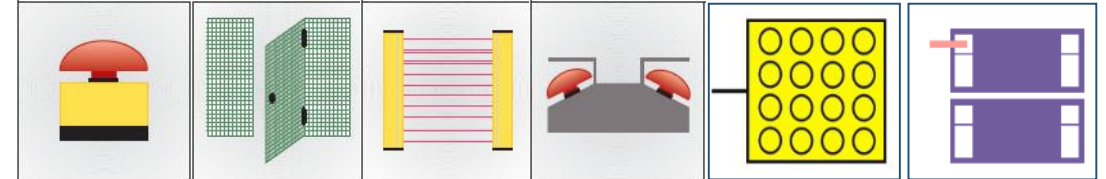

- EMO
- Interlock SW
- Light Curtain
- Two-hand SW
- Mat
- Non-contact SW

PLe/Cat.4

EN ISO13849

PA



- DO
- Feedback
- EDM
- Heavy loader

SIL3

IEC 61508

IEC 61511

Fit specific process requirements

Support:



Specialized IO (on-going)

Intrinsic Safety, Function Safety, IP67 etc



CHENZHU CTOP

- Miniaturization
- Specialized
- Intelligence
- Customized



PLC Control Function based on IEC61131-3

Application: Chemical

CHENZHU

Customer	BAOFENG ENERGY--Ningxia Province, Northwest of China
Application	Production of 2.2 million tons of methanol DCS project GS8500-EX were used more than 10,000 pcs

Product	Type	CHENZHU Model	Qty
Isolated Barrier	AI	GS8547-EX	7100
Isolated Barrier	AO	GS8567-EX	1500
Isolated Barrier	DI	GS8512-EX.11	1600
Isolated Barrier	DI	GS8519-EX.11	750

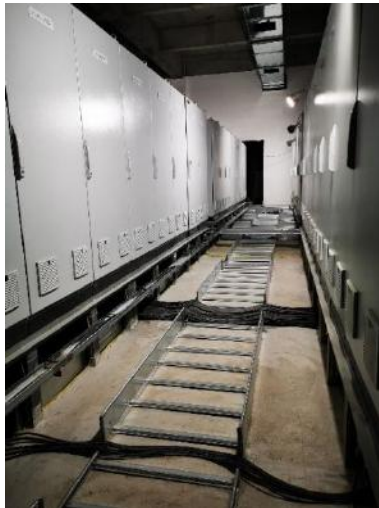
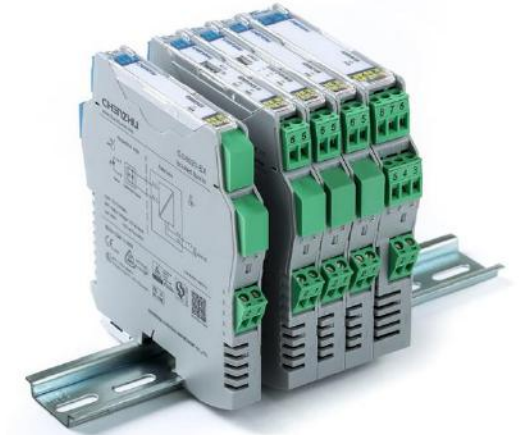
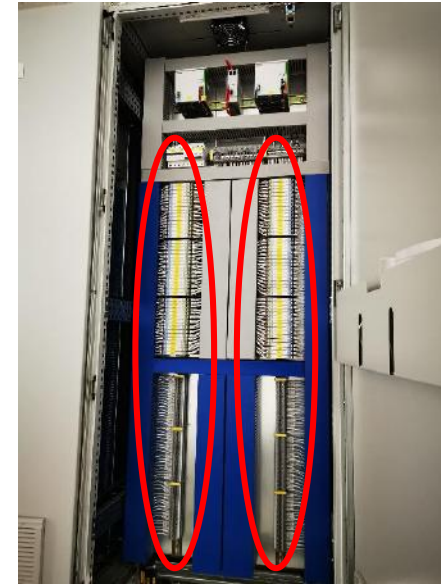

Application: Fluorine Chemical Industry

Customer	3F Zhongdao
Application	Hydrogen fluoride, tetrafluoropropanol, hexafluoropropane acetylene, GS8500-EX were used more than 3,700 pcs

Product	Type	CHENZHU Model	Qty
Isolated Barrier	AI	GS8536-EX	★★★★★
Isolated Barrier	AO	GS8568-EX	★★★★★
Isolator	TI	GS8572-EX	★★★★★
SPD	DI	GS8512-EX.22	★★★★★



★★★★★: 801-1000
★★★★: 401-800
★★★: 201-400
★★: 101-200
★: 1-100

Application: Gas Industry

Customer	Indonesia XX Power Solution Group
Application	Wireless remote transmission of gas data Solar street lighting control system

Product	Type	CHENZHU Model	Qty
Isolated Barrier	RS-485 to RS-485	GS8593-EX.3	★★★★
Isolated Barrier	RS-485 to RS-232	GS8596-EX.3	★★★★
Isolator	AI	CZ3047/CZ3035	★
SPD	Power SPD	T2-20/2P	★



- ★★★★★: 801-1000
- ★★★★: 401-800
- ★★★: 201-400
- ★★: 101-200
- ★: 1-100

Application: Natural Gas Industry

Customer	Gas gate station company
Application	Pressure regulating station and gas fueling station

★★★★★: 801-1000
 ★★★★★: 401-800
 ★★★: 201-400
 ★★: 101-200
 ★: 1-100

Product	Type	CHENZHU Model	Qty
Isolated Barrier	RS-485 to RS-485	GS8593-EX.3	★★★★★
Isolated Barrier	RS-485 to RS-232	GS8596-EX.3	★★★★★
Isolated Barrier	AI	GS8547-EX	★★★
SPD	Signal SPD/Screwable SPD	T-24-EX-L/CZLBX-48	★★★



Application: Gas Compressor

Customer	CNPC 
Application	PetroChina ,cumulative application more than 10,000 pcs

★★★★★: 801-1000
 ★★★★★: 401-800
 ★★★★★: 201-400
 ★★★★★: 101-200
 ★★★★★: 1-100

Product	Type	CHENZHU Model	Qty
Isolated Barrier	AI	GS8547-EX	★★★★★
Isolated Barrier	AO	GS8567-EX	★★★★★
Isolated Barrier	DI	GS8512-EX.22	★★★★★
Isolated Barrier	TI	GS8572-EX	★★★★★



Application: Construction Machinery

Customer	China Railway Engineering Equipment Group Co., Ltd Northern Heavy Industry Group
Application	Tunnel boring machine

Product	Type	CHENZHU Model	Qty
Isolated Barrier	AI	GS8547-EX	★★★★
Isolated Barrier	DI	GS8512-EX.22	★★★★
Isolated Barrier	RTD	GS8579-EX.RTD	★
Isolated Barrier	FI	GS8554-EX.22	★
Isolated Barrier	Potentiometer	GS8579-EX.R	★
Isolated Barrier	RS-485	GS8593-EX.3	★
Isolator	AI	CZ3047/CZ3035	★
SPD	AC Power SPD (T2)	T2-20/3P	★
Safety Relay	E-stop button; 24V	CZSR8001-3A1B	★★★★★
Safety Relay	E-stop button; 220V	CZSR8003-3A1B	★★★★
Safety Relay	Two-hand push buttons	CZSR8201-3A1B	★



- ★★★★★: 801-1000
- ★★★★: 401-800
- ★★★: 201-400
- ★★: 101-200
- ★: 1-100

Application: Machinery

Rubber Machinery



Type	CHENZHU Model
E-stop button; 24V	CZSR8001-3A1B
Safety touch edge; 24V	CZSR8302-3A1B
Safety mat; 24V	CZSR8301-3A1B

Forging Machinery

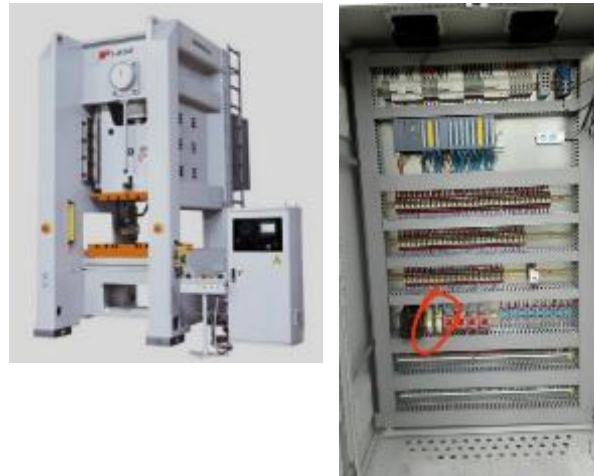

Type	CHENZHU Model
E-stop button; light curtain	CZSR8001-3A1B-P
Two-hand button	CZSR8201-3A1B

Packing Machinery



Type	CHENZHU Model
E-stop button; 24V	CZSR8001-3A1B

Our Advantages

Professional Marketing Networks

R&D background for our product managers
Rich application experience and local resource



Strong R&D Team

20+ years experience
Spend more than 10% of sales amount per year to R&D



Added Value

Collaborative with our partner for success



Smart Production

Continually driven by lean management and flexible production. Ensure the production meets the design specification and satisfies our customers.



Our Vision

No striving to be the biggest but the strongest,
No striving to be the best but the better,
Provide the best industrial safety interface products and services.

Technology

Focus on core technologies,
Keep innovation and improvement

Manufacture

+Internet, Smart factory
Meer user' s need better

Brand

International Strategy
Your better partner

Product/Service

Pursue for better performance,
better quality



Local & international seminars

CHENZHU

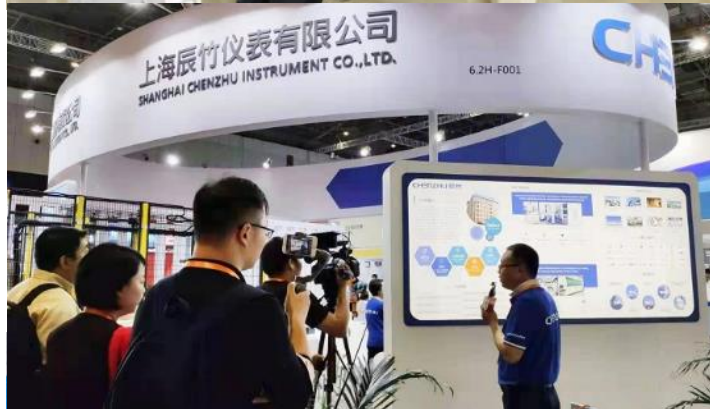

CHENZHU



Internal Training

CHENZHU



六顶思考帽

TRAINING INVITATION

星期五下午
二〇一七年七月十四日



世界创新思维、概念思维专家
爱德华·德·博诺

【从对抗性思考到平行思考】

这是一种思维工具的学习；
如果思考能力不增强，其他的什么能力都要打折扣。

地点：上海辰竹仪表有限公司8楼培训室
讲师：李丹丹

Focus on electronic function safety technologies



Shanghai Institute of Technology

Since 2017

CHENZHU funded SIT scholarship



East China University of Science and Technology

Cooperated since 2008

Established engineering masters training at 2013

6~12 engineer masters will join us for 1 year internship

And finish their paper

CHENZHU funded the ECUST scholarship since 2013



University of Shanghai for Science and Technology

Since 2008

Excellent Work, Colorful Life





Looking for Agent !

If you are interested to be our agent in your market,
we will be your strong backup.

Thank You !



Alibaba

SHANGHAI CHENZHU INSTRUMENT CO.,LTD.

Isolated Barrier | Signal Isolator | SPD | Safety Relay | Smart Controller



Website